

RACCORDI A COMPRESSIONE, RACCORDI A BICONO E RACCORDI UNIVERSALI

COMPRESSION FITTINGS, DOUBLE CONE FITTINGS AND UNIVERSAL FITTINGS

KLEMMRING VERSCHRAUBUNGEN, DOPPELKEGEL VERSCHRAUBUNGEN, UNIVERSAL VERSCHRAUBUNGEN

RACCORDS À COMPRESSION, RACCORDS À BICONE, RACCORDS UNIVERSELS LAITON







RACORDAJE A COMPRESIÓN, RACORDAJE UNIVERSAL A BICONO, RACORDAJE UNIVERSAL

CONEXÕES DE COMPRESSÃO, CONEXÕES UNIVERSAIS DE CONE DUPLO, CONEXÕES UNIVERSAIS



Serie Compression Fittings

Serie 9000

 9200 Pag. 16.8	 9220 Pag. 16.8	 9230 Pag. 16.8	 9260 Pag. 16.8	 9280 Pag. 16.9	 9460 Pag. 16.9	 9480 Pag. 16.9	 9500 Pag. 16.9	 9550 Pag. 16.10
 9680 Pag. 16.10	 9740 Pag. 16.10	 10770 Pag. 16.10						

Serie 10000

 10200 Pag. 16.14	 10220 Pag. 16.14	 10230 Pag. 16.14	 10240 Pag. 16.14	 10260 Pag. 16.15	 10280 Pag. 16.15	 10290 Pag. 16.15	 10460 Pag. 16.15	 10465 Pag. 16.16
 10480 Pag. 16.16	 10485 Pag. 16.16	 10500 Pag. 16.17	 10510 Pag. 16.17	 13530 Pag. 16.17	 13540 Pag. 16.18	 10550 Pag. 16.18	 10680 Pag. 16.18	 10740 Pag. 16.18
 10760 Pag. 16.19	 10770 Pag. 16.19	 13780 Pag. 16.19	 1612 Pag. 16.19	 1613 Pag. 16.19				

Serie 13000

 13200 Pag. 16.23	 13220 Pag. 16.23	 13230 Pag. 16.23	 13240 Pag. 16.23	 13260 Pag. 16.24	 13280 Pag. 16.224	 13290 Pag. 16.24	 13300 Pag. 16.25	 13460 Pag. 16.15
 13465 Pag. 16.15	 13480 Pag. 16.25	 13483 Pag. 16.26	 13485 Pag. 16.26	 13500 Pag. 16.27	 13510 Pag. 16.27	 13530 Pag. 16.27	 13540 Pag. 16.28	 13550 Pag. 16.28
 13550BI Pag. 16.28	 13570BI Pag. 16.29	 13958BI Pag. 16.29	 13600 Pag. 16.29	 13680 Pag. 16.29	 13740 Pag. 16.30	 13780 Pag. 16.30	 10770 Pag. 16.30	 1612 Pag. 16.30
 1613 Pag. 16.30	 13800 Pag. 16.31	 13810 Pag. 16.32	 13820 Pag. 16.32	 TBPL Pag. 16.33 - 16.34				

9000
10000
13000

Le 3 gamme di raccordi a compressione in ottone Aignep si differenziano principalmente per le normative di riferimento, le applicazioni e le caratteristiche tecniche delle ogive.

Con queste tre tipologie Aignep rappresenta la scelta più ampia del mercato e riesce a risolvere problemi applicativi ben noti. Le possibilità di utilizzo e di connessione sono molteplici, si possono connettere in assoluta sicurezza tubi rigidi metallici (ottone, rame, alluminio) e tubi in materiali termo plastici come poliuretano, poliammide e teflon. Disponibili Ogive in teflon.

Serie 9.000	DIN 3861
Serie 10.000	DIN 3862 (Bicono)
Serie 13.000	UNI EN 1254 2:2000 (universale)

Principali vantaggi

- 3 tecnologie di connessione
- Compatibilità numerosi fluidi industriali
- Tenuta garantita su differenti tipologie di tubi
- Senza elementi di tenuta (elastomeri)
- Dal \varnothing 4 al \varnothing 22 mm
- Robustezza meccanica
- Versioni con nichelatura
- Silicon Free

Applicazioni

- Automazione Pneumatica pesante
- Automotive
- Raffreddamento industriale
- Gas inerti, vapore, lubrificazione
- Vuoto

Aignep offers 3 lines of compression fittings in brass according to different manufacturing directives. This wide selection helps to satisfy the most demanding needs of the market.

Especially designed for connection with metallic tubes (brass, copper, aluminium) to secure connection in low-medium pressure. Connection with PU, PA and PTFE tubes with a smart internal bush.

9.000 Serie	DIN 3861
10.000 Serie	DIN 3862 (Dual cone)
13.000 Serie	UNI EN 1254 2:2000 (Universal)

Main advantages

- 3 Connection Technologies
- All industrial fluids compatibility
- Secured connection with different tubes
- Metallic sealing
- From \varnothing 4 to 22 mm
- Mechanical Resistance
- Nickel-plated version
- Silicon Free

Applications

- Heavy Pneumatic Automation
- Automotive
- Industrial cooling
- Inert Gases, Steam
- Vacuum

Aignep bietet drei Serien von Klemmringverschraubungen aus Messing an, welche sich vor allem durch verschiedene Herstellungsrichtlinien unterscheiden. Dank dieser großen Auswahl können auch die anspruchsvollsten Nachfragen erfüllt werden.

Speziell entwickelt für die sichere Verbindung von Metall-Rohren (Messing, Kupfer, Aluminium) bei geringem bis mittlerem Druck. Verbindung mit PU, PA und PTFE-Schläuchen mit einer Stützhülse.

9.000er Serie	DIN 3861
10.000er Serie	DIN 3862 (Doppelkegel)
13.000er Serie	UNI EN 1254 2:2000 (Universal)

Hauptvorteile

- 3 Verbindungs-Technologien
- Kompatibel mit allen Medien
- Sichere Verbindung mit allen Rohren
- Metall-Dichtungen
- Von \varnothing 4 bis 22 mm
- Mechanische Festigkeit
- Vernickelte Version
- Silikonfrei

Anwendungen

- Schwere pneumatische Automation
- Automotive
- Industrie-Kühlung
- Inertgase, Dampf

Aignep propose 3 gammes de raccords à compression en laiton selon différentes normes.

Cette large sélection permet de répondre à tous les besoins dans de nombreuses applications industrielles.

Spécialement conçus pour le raccordement avec des tubes métalliques rigides (Laiton, cuivre, aluminium) ils garantissent une parfaite sécurité dans la connexion en basse et moyenne pression.

Raccordement avec du tube PU, PA et PTFE possibles en utilisant une fourrure intérieure.

Série 9000	selon DIN 3861
Série 10000	selon DIN 3862 (Bi cone)
Série 13000	selon UNI EN 1254 2: 2000 (Universelle)

Principaux avantages

- 3 Technologies de raccordement
- Compatibilité avec tous les fluides industriels
- Connexion sécurisée avec différents tubes
- Étanchéité métal/métal
- De \varnothing 4 à 22 mm
- Excellente résistance mécanique
- Versions nickelées ou brute
- Sans silicone

Applications

- Automatismes pneumatiques – milieux sévères
- Process Automobile
- Refroidissement industriel
- Gaz neutre, vapeur
- Vide

Las 3 gamas de racores a compresión en latón Aignep se diferencian principalmente por las normativas de referencia, las aplicaciones y las características técnicas de los anillos.

Con estas tres tipologías Aignep representa la elección mas amplia del mercado y resuelve problemas aplicativos de forma notable. Las posibilidades de utilización y de conexión son múltiples, pueden conectarse con absoluta seguridad tubos rígidos metálico (latón, cobre, aluminio) y tubos en material plástico como poliuretano, poliamida y teflón. Disponibles anillos en teflón.

Serie 9.000	DIN 3861
Serie 10.000	DIN 3862 (bicono)
Serie 13.000	UNI EN 1254 2:2000 (Universal)

Principales ventajas

- 3 tecnologías de conexión
- Compatibilidad con numerosos fluidos industriales
- Estanqueidad garantizada con diferentes tipologías de tubo
- Sin elementos de estanqueidad (Elastomeros)
- Del diam. 4 al diam 22 mm
- Robustez mecánica
- Versión con niquelatura
- Libres de silicona

Aplicaciones

- Automatización neumática pesada
- Automoción
- Refrigeración industrial
- Gases inertes, vapor, lubricación
- Vácuo

A Aignep oferece 3 linhas de conexões de compressão em latão de acordo com diferentes diretivas de fabricação.

Esta ampla gama de itens auxilia a atender as mais complexas necessidades do mercado.

Especialmente desenvolvido para conectar tubos metálicos (latão, cobre, alumínio) e assegurar conexões em pressões médias e baixas.

Conexão com tubos em PU, PA e PTFE através de uma bucha interna.

9.000 Série	DIN 3861
10.000 Série	DIN 3862 (Dual cone)
13.000 Série	UNI EN 1254 2:2000 (Universal)

Principais vantagens

- 3 Tecnologia de Conexão
- Compatibilidade com todos os fluidos industriais
- Conexão segura com diferentes tubos
- Vedação Metálica
- Para tubos de \varnothing 4 a 22 mm
- Resistência Mecânica
- Versão Niquelada
- Livre de Silicone

Aplicações

- Automação Pneumática Pesada
- Automotiva
- Refrigeração Industrial
- Gases Inertes, Vapor
- Vácuo

RACCORDI UNIVERSALI A BICONO*UNIVERSAL DOUBLE CONE FITTINGS**DOPPELKEGEL VERSCHRAUBUNGEN**RACCORDS UNIVERSELS A DOUBLE CONE**RACORDAJE UNIVERSAL A BICONO**CONEXÕES UNIVERSAIS DE CONE DUPLO*



CARATTERISTICHE TECNICHE
 TECHNICAL CHARACTERISTICS
 TECHNISCHE ANGABEN
 CARACTÉRISTIQUES TECHNIQUES
 CARACTERÍSTICAS TÉCNICAS
 CARACTERÍSTICAS TÉCNICAS



Norma di Riferimento
 Reference standard
 Entspricht der Norm
 Norme de référence
 Normativa de referencia
 Norma de referência

1907/2006

REACH ✓

2011/65/CE

RoHS ✓

PED

2014/68/UE

SILICON

FREE

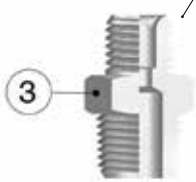

Sede e bicono a norma DIN 3862.
 Seat and olive in conformity with
 DIN Standards 3862.
 Ein Registriert unter DIN 3862 Bicone.
 Un enregistré en application DIN 3862 bicone.
 Sede y bicono a norma DIN 3861.
 Sede e bucha conforme Norma DIN 3862.



Rinforzo Art. 10770.
 Internal support bush Art. 10770.
 Verstärkung Art. 10770.
 Renforcement Art. 10770.
 Refuerzo Art. 10770.
 Bucha de reforço interno Cód. 10770.

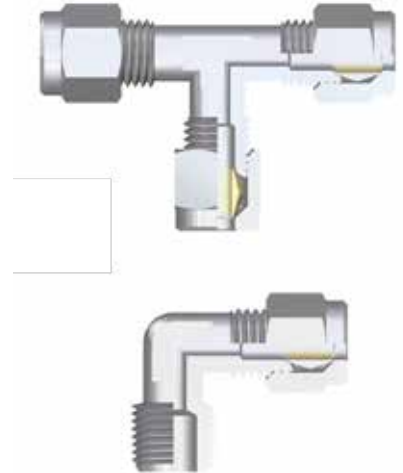

Materiali e Componenti	IT	Component Parts and Materials	GB	Komponenten und Materialien	DE
1 Dado in Ottone Nichelato		1 Nickel-plated Brass Nut		1 Überwurfmutter Messing vernickelt	
2 Ogiva in Ottone (PTFE a richiesta)		2 Brass Olive (If requested PTFE)		2 Klemmring Messing (PTFE auf Anfrage)	
3 Corpo in Ottone Nichelato		3 Nickel-plated Brass Body		3 Körper Messing vernickelt	
4 Bussolina di rinforzo		4 Internal support bush		4 Stützhülse Messing	

Matériaux et Composants	FR	Materiales y Componentes	ES	Materiais e Componentes	PT
1 Ecrou: laiton nickelé		1 Tuerca en Latón Niquelado		1 Porca em Latão niquelado	
2 Ague: laiton (sur demande en PTFE)		2 Bicono en Latón (PTFE a demanda)		2 Bucha em Latão (PTFE sob encomenda)	
3 Corps: laiton nickelé		3 Cuerpo en Latón Niquelado		3 Corpo em Latão niquelado	
4 Fourrure intérieure: laiton		4 Refuerzo		4 Bucha de reforço interna	



Tubi di Collegamento	IT	Connection Tubes	GB	Geeignete Rohre	DE
Tubi in rame, ferro, acciaio, alluminio, ottone, ecc. Con apposito rinforzo interno (art. 10770), possono essere utilizzati anche tubi in PA11, PA6, ecc.		Tubes made in copper, steel, iron, aluminium, brass, etc. With an inside support bush (art. 10770), can be used also for plastic material such as PA11, PA6, etc.		Rohre in Kupfer, Eisen, Stahl, Aluminium, Messing, usw. Mit einer internen Stützhülse (Art. 10770), können auch Rohre aus PA11, PA6, usw. verwendet werden.	

Tubes Conseillés	FR	Tubos de Conexión	ES	Tubos de Conexão	PT
Tubes en cuivre, acier, aluminium, laiton, etc. Avec une fourrure intérieure (art. 10770), les tubes plastiques PA11, PA6, etc. peuvent être utilisés.		Tubos en cobre, hierro, acero, aluminio, latón, etc. Con el correspondiente refuerzo interno (art. 10770), pueden utilizarse también con tubo en PA11, PA6, etc.		Tubos de cobre, ferro, aço, alumínio, latão, etc. Com bucha de reforço interna (cód. 10770), podem ser utilizados também com tubos em PA11, PA6, etc.	



Filettatura	IT	Threads	GB	Gewindearten	DE
Gas conica conforme ISO 7.1, BS 21, DIN 2999. Gas cilindrica conforme ISO 228 Classe A. Metrica conforme ISO R/262.		Tapered gas in conformity with ISO 7.1, BS 21, DIN 2999. Parallel gas in conformity with ISO 228 Class A. Metric in conformity with ISO R/262.		Konisches Gewinde nach Norm ISO 7.1, BS 21, DIN 2999. Zylindrisches Gewinde nach Norm ISO 228 Classe A. Metrisches Gewinde nach Norm ISO R/262.	

Filetages	FR	Roscas	ES	Roscas	PT
Filetage conique conforme: ISO 7.1, BS 21, DIN 2999. Filetage cylindrique conforme: ISO 228 Classe A. Filetage métrique conforme: ISO R/262.		Gas cónica conforme ISO 7.1, BS 21, DIN 2999. Gas cilíndrica conforme ISO 228 Clase A. Métrica conforme ISO R/262.		Gas cônica conforme ISO 7.1, BS 21, DIN 2999. Gas paralela conforme ISO 228 Classe A. Métrica conforme ISO R/262.	



Pressioni e Temperature

IT

Pressioni e temperature vengono determinate dal tipo di tubo impiegato, pertanto tali valori sono da definirsi in base alle caratteristiche del tubo stesso.

Riportiamo di seguito i valori delle pressioni massime consigliate per l'utilizzo dei raccordi con tubi di rame dallo spessore di 1 mm a 20° C.

I valori delle pressioni consigliate, riportate in tabella, sono stati ottenuti dai valori di prova adottando un Coefficiente di Sicurezza 4.

Sono disponibili i certificati delle prove rilasciati dai vari laboratori che le hanno eseguite.

Pressures and Temperatures

GB

The working pressures and working temperatures depend on which type of tube is used, for this reason, the values must be determined in accordance with the tube's features.

Hereunder, we specify the values of the maximum pressure advised for the fittings at a temperature of 20° C connected with copper tube, which has a thickness of 1 mm.

The values of working pressures advised, specified in table have been obtained from the test values using a Safety Factor 4.

It is available the test report made by the external laboratory test.

Druckbereich und Temperatur

DE

Drücke und Temperaturen sind definiert durch die verwendete Ausführung der Leitung, d.h. die Werte der eingesetzten Rohre sind zu beachten.

Nachfolgend geben wir die Werte des maximalen Druckes für den Einsatz der Verschraubungen mit Kupferrohren an, deren Wandstärke min. 1mm beträgt und bei einer Temperatur von 20° C.

Es muss berücksichtigt werden, dass die angegebenen Druckwerte in der Tabelle mit einem Sicherheitsfaktors von 4 berechnet wurden.

Es stehen Prüfberichte zur Verfügung, die von verschiedenen, externen Labors gemacht wurden.

Pressions et Températures

FR

Les pressions et températures de service dépendent du type de tube utilisé. Pour cette raison, les valeurs doivent être déterminées en conformité avec les caractéristiques du tube. Ci-dessous, nous indiquons les valeurs de la pression maximale recommandée pour une connexion avec un tube en cuivre de 1 mm d'épaisseur à une température de 20° C.

Les pressions de service indiquées ont été calculées avec un coefficient de sécurité de 4.

Des rapports externes de tests sont disponibles sur demande pour attester ces valeurs.

Presiones y Temperaturas

ES

Presión y temperatura vienen determinadas según el tipo de tubo empleado, por lo tanto estos valores se definen en base a las características del mismo tubo. Representamos a continuación los valores de las presiones máximas aconsejadas para la utilización de los racores con tubo de cobre espesor 1 mm a 20° C.

Los valores de las presiones aconsejadas, representadas en la tabla, han sido obtenidas de valores de prueba adoptando un coeficiente de seguridad 4.

Están disponibles los certificados de las pruebas realizadas en distintos laboratorios especializados.

Pressões e Temperaturas

PT

Pressões e temperaturas dependem do tipo de tubo aplicado, portanto tais valores devem ser definidos com base nas características do tubo em questão.

A seguir apresentamos os valores das pressões máximas aconselhadas para a utilização das conexões com tubos de cobre de espessura de 1 mm a 20° C.

Os valores das pressões aconselhadas, reportados na tabela, foram obtidas dos valores de teste adotando-se um Coeficiente de Segurança 4.

Os certificados de teste executados por laboratórios externos estão disponíveis.



Temperature

Temperatures

Temperatur

Températures

Temperaturas

Temperaturas

- 60 °C
+ 300 °C

Misura Size Größe Dimensions Tamaño Tamanho	Pressione massima consigliata - 20 °C Maximum pressure advised - 20 °C Maximal empfohlener Druck - 20 °C Pression maximum conseillée - 20 °C Presión máxima aconsejada - 20 °C Pressão máxima aconselhada - 20 °C
Ø	kg/cm ² bar
4	150 148.4
6	150 148.4
8	130 128.6
10	180 178.1
12	150 148.4
14	115 113.3
15	75 74.2
16	75 74.2
18	60 59.4
22	40 39.6



Fluidi compatibili

Acqua / Olio / Aria compressa

Fluidi in genere per l'impiantistica idraulica, oleodinamica, idropneumatica, ecc.

Fluids

Water / Oils / Compressed air

Fluids in general for the hydraulic, pneumatic and oildynamic plants etc.

Geeignete Medien

Wasser / Öl / Druckluft

Medien im Allgemeinen für hydraulische-, hydropneumatische- und pneumatische Anlagen, usw.

Fluides compatibles

Eau / Huile / Air comprimé

Fluides courants utilisés en hydraulique et pneumatique, etc.

Fluidos compatibles

Agua / Aceite / Aire comprimido

Fluidos en general para los campos hidráulicos, neumáticos y oleodinámicos, etc.

Fluidos compatíveis

Água / Óleo / Ar comprimido

Fluidos em geral para aplicações hidráulicas, oleodinâmicas, hidropneumáticas, etc.



Coppia di serraggio

Torque specifications

Angaben Drehmoment

Couple de serrage

Par de apriete

Especificações de Torque

COPPIE DI SERRAGGIO DADO SU OGIVA TORQUE FORCE ON OLIVE NUT ANZUGSDREHMOMENT ZWISCHEN MUTTER UND KLEMMRING COUPLE DE SERRAGE DE L'ÉCROU SUR LA BAGUE OLIVE PAR DE APRIETE DE LA TUERCA DE OJIVA TORQUE DE APERTO PARA PORCA EM BUCHA			
Ø	N° Giri chiave N° Key turns N° Schlüssel Umdrehungen N° de tours N° Giro de la tuerca N° Rotação da porca	Forza Force Drehmoment Couple Fuerza Força	Forza Force Drehmoment Couple Fuerza Força
mm		Nm	kgf
4	1 1/4 + 1/4	15	1.55
6	1 1/4 + 1/4	18	1.85
8	1 1/4 + 1/4	22	2.25
10	1 1/4 + 1/4	40	4
12	1 1/4 + 1/4	50	5
14	1 1/4 + 1/4	70	7.1
15	1 + 1/4	90	9.1
16	1 + 1/4	90	9.1
18	1 + 1/4	130	13.25
22	1 + 1/4	130	13.25

Forze di serraggio, minime consigliate, e n° di giri utili, per garantire un montaggio corretto.
Torque force, minimum recommended, and useful turn, to ensure a correct installation.
Empfohlenes Anzugsdrehmoment und mindest umdrehungsanzahl für eine korrekte montage.
Couple de serrage minimum recommandé et nombre de tours pour assurer une installation correcte.
Par de apriete mínimo recomendado y n. giros necesarios para garantizar un montaje correcto.
Torque de aperto mínimo garantido, n. rotações necessário para garantir a correcta instalação.

10200

RACCORDO A T INTERMEDIO

TEE CONNECTOR

T-ANSCHLUSS

RACCORD TÉ

RACOR A T INTERMEDIO

CONEXÃO EM "T" TUBO-TUBO

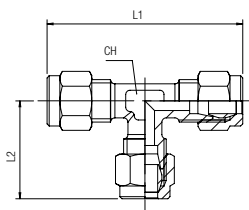

Code	Tube	L1	L2	CH	Pack.
10200 00 001	4	41	20.5	8	10
10200 00 002	6	46	23	9	10
10200 00 003	8	53	26.5	12	10
10200 00 004	10	62	31	13	10
10200 00 005	12	67	33.5	14	10
10200 00 006	14	72	36	18	10
10200 00 007	15	78	39	18	10
10200 00 008	16	78	39	17	10
10200 00 009	18	83	41.5	20	10
10200 00 010	22	86	43	27	10

10220

RACCORDO A T MASCHIO CENTRALE

TEE MALE ADAPTOR CENTRE LEG

T-EINSCHRAUBVERSCHRAUBUNG KONISCH

TÉ À PIQUAGE MÂLE CENTRAL, CONIQUE

RACOR A T MACHO CENTRAL

CONEXÃO EM "T" COM ROSCA MACHO CENTRAL

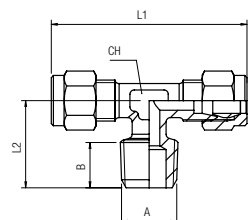

Code	Tube	A	L1	L2	CH	Pack.
10220 00 001	4	1/8	41	15	8	10
10220 00 002	6	1/8	46	16.5	9	10
10220 00 003	6	1/4	46	20.5	9	10
10220 00 004	8	1/8	53	16.5	12	10
10220 00 005	8	1/4	53	20.5	12	10
10220 00 006	8	3/8	57	23	13	10
10220 00 007	10	1/4	62	22.5	13	10
10220 00 008	10	3/8	62	23.5	13	10
10220 00 009	10	1/2	64	27	14	10
10220 00 010	12	1/4	66	24.5	14	10
10220 00 011	12	3/8	66	25	14	10
10220 00 012	12	1/2	67	26.5	14	10
10220 00 013	14	3/8	75	26	16	10
10220 00 014	14	1/2	78	31	18	10
10220 00 015	15	1/2	80	31	18	10
10220 00 016	16	1/2	79	29	17	10
10220 00 017	18	1/2	84	29.5	20	10
10220 00 018	18	3/4	82	32.5	20	10
10220 00 019	22	3/4	86	34	27	10

10230

RACCORDO A T MASCHIO LATERALE

TEE MALE ADAPTOR OFF SET LEG

L-EINSCHRAUBVERSCHRAUBUNG KONISCH

TÉ À PIQUAGE LATÉRAL, CONIQUE

RACOR A T MACHO LATERAL

CONEXÃO EM "T" COM ROSCA MACHO LATERAL

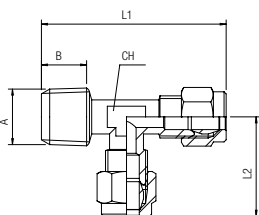

Code	Tube	A	L1	L2	CH	Pack.
10230 00 001	4	1/8	35	21	8	10
10230 00 002	6	1/8	39	24	9	10
10230 00 003	6	1/4	43	23	9	10
10230 00 004	8	1/8	43	26	12	10
10230 00 005	8	1/4	46	26	12	10
10230 00 006	8	3/8	49	26	13	10
10230 00 007	10	1/4	55	31	13	10
10230 00 008	10	3/8	54	31	13	10
10230 00 009	12	3/8	58	33	14	10
10230 00 010	12	1/2	59	34	15	10
10230 00 011	14	1/2	67	39	18	10

10240

RACCORDO A T FEMMINA CENTRALE

TEE FEMALE CENTRE LEG

T-EINSCHRAUBVERSCHRAUBUNG INNENGEWINDE

TÉ FEMELLE CENTRAL

RACOR A T HEMBRA CENTRAL

CONEXÃO EM "T" COM ROSCA FÊMEA CENTRAL

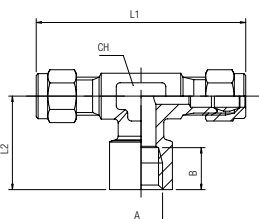

Code	Tube	A	L1	L2	CH	Pack.
10240 00 001	4	1/8	42	18	8	10
10240 00 002	6	1/8	46.5	19.5	9	10
10240 00 003	6	1/4	54	24.5	13	10
10240 00 004	8	1/8	53	19.5	12	10
10240 00 005	8	1/4	55	24.5	13	10
10240 00 007	10	1/4	63	24.5	13	10
10240 00 008	10	3/8	65	26	14	10
10240 00 009	10	1/2	66	26	15	10
10240 00 010	12	1/4	66	25.5	14	10
10240 00 011	12	3/8	66	26	14	10
10240 00 012	12	1/2	66	26	15	10
10240 00 013	14	1/2	67	30	18	10
10240 00 014	15	1/2	77	30	18	10
10240 00 015	16	1/2	77	28.5	17	10
10240 00 016	18	1/2	84	28	20	10
10240 00 017	18	3/4	83	34	20	10

10260

RACCORDO A L INTERMEDIO

ELBOW CONNECTOR
WINKELVERSCHRAUBUNG
RACCORD EQUERRE
RACOR A L INTERMEDIO
CONEXÃO EM "L" TUBO-TUBO

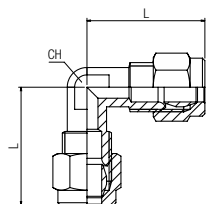

Code	Tube	L	CH	Pack.
10260 00 001	4	20	8	10
10260 00 002	6	24	9	10
10260 00 003	8	28	11	10
10260 00 004	10	32	13	10
10260 00 005	12	34	14	10
10260 00 006	14	36.5	17	10
10260 00 007	15	38	17	10
10260 00 008	16	39	17	10
10260 00 009	18	41.5	20	10
10260 00 010	22	43	27	10

10280

RACCORDO A L MASCHIO

ELBOW MALE ADAPTOR
WINKELVERSCHRAUBUNG KONISCH
EQUERRE MÂLE, CONIQUE
RACOR A L MACHO
CONEXÃO EM "L" COM ROSCA MACHO

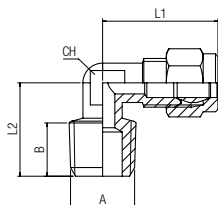

Code	Tube	A	L1	L2	CH	Pack.
10280 00 001	4	1/8	20.5	15	8	10
10280 00 002	6	1/8	23.5	17	9	10
10280 00 003	6	1/4	23.5	19	9	10
10280 00 004	8	1/8	28	18	11	10
10280 00 005	8	1/4	28	21.5	11	10
10280 00 006	8	3/8	28.5	24	13	10
10280 00 007	10	1/4	32	23.5	13	10
10280 00 008	10	3/8	32	24.5	13	10
10280 00 009	10	1/2	34	25	14	10
10280 00 010	12	1/4	34	24	14	10
10280 00 011	12	3/8	34	26	14	10
10280 00 012	12	1/2	34	25	14	10
10280 00 013	14	3/8	38	26	17	10
10280 00 014	14	1/2	38	28.5	17	10
10280 00 015	15	1/2	39	28.5	17	10
10280 00 016	16	1/2	40	28	17	10
10280 00 017	18	1/2	42	29.5	20	10
10280 00 018	18	3/4	42	32	20	10
10280 00 019	22	3/4	42.5	34	27	10

10290

RACCORDO A L FEMMINA

ELBOW FEMALE ADAPTOR
WINKELVERSCHRAUBUNG INNENGEWINDE
EQUERRE FEMELLE
RACOR A L HEMBRA
CONEXÃO EM "L" COM ROSCA FÊMEA

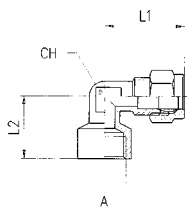

Code	Tube	A	L1	L2	CH	Pack.
10290 00 001	4	1/8	22	18	8	10
10290 00 002	6	1/8	23.5	18	9	10
10290 00 003	6	1/4	24	22.5	11	10
10290 00 004	8	1/8	28	21	11	10
10290 00 005	8	1/4	28.5	25.5	13	10
10290 00 006	8	3/8	29	25	14	10
10290 00 007	10	1/4	34	25	13	10
10290 00 008	10	3/8	33	25	14	10
10290 00 009	10	1/2	33	27	15	10
10290 00 010	12	1/4	34	26	14	10
10290 00 011	12	3/8	34	26	14	10
10290 00 012	12	1/2	33	27	15	10
10290 00 013	14	1/2	38.5	30	18	10
10290 00 014	15	1/2	39	30	18	10
10290 00 015	16	1/2	40	30	18	10
10290 00 016	18	1/2	42	29	20	10
10290 00 017	18	3/4	42	33.5	20	10

10460

RACCORDO DIRITTO INTERMEDIO

STRAIGHT CONNECTOR
VERBINDUNGSVERSCHRAUBUNG
RACCORD UNION DOUBLE
RACOR RECTO INTERMEDIO
CONEXÃO RETA TUBO-TUBO

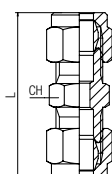

Code	Tube	L	CH	Pack.
10460 00 001	4	30.5	10	10
10460 00 002	6	35	11	10
10460 00 003	8	36	13	10
10460 00 004	10	43.5	16	10
10460 00 005	12	44	18	10
10460 00 006	14	47	21	10
10460 00 007	15	52	21	10
10460 00 008	16	52.5	22	10
10460 00 009	18	56.5	26	10
10460 00 010	22	55	30	10

10465

RACCORDO DRITTO INTERMEDIO DI ATTRAVERSAMENTO

STRAIGHT BULKHEAD CONNECTOR
 SCHOTTVERSCHRAUBUNG
 RACCORD DROIT TRAVERSÉE DE CLOISON
 RACOR RECTO INTERMEDIO PASATABIQUES
 CONEXÃO RETA PASSAMURO TUBO-TUBO

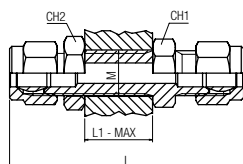

Code	Tube	L	L1 max	CH1	CH2	M	Pack.
10465 00 001	4	46.5	15	10	13	M8x1	10
10465 00 002	6	51.5	15	14	14	M10x1	10
10465 00 003	8	53	15	14	17	M12x1	10
10465 00 004	10	61.5	16	19	21	M16x1,5	10
10465 00 005	12	67.5	20	22	24	M18x1,5	10
10465 00 006	14	72	20	24	24	M20x1,5	10

10480

RACCORDO DIRITTO MASCHIO CONICO

STRAIGHT MALE ADAPTOR (TAPER)
 GERADE EINSCHRAUBVERSCHRAUBUNG KONISCH
 RACCORD DROIT MÂLE CONIQUE
 RACOR RECTO MACHO
 CONEXÃO RETA COM ROSCA MACHO

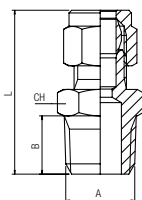

Code	Tube	A	L	CH	Pack.
10480 00 001	4	1/8	25.5	11	10
10480 00 002	4	1/4	28.5	14	10
10480 00 003	6	1/8	27.5	11	10
10480 00 004	6	1/4	31	14	10
10480 00 005	6	3/8	31.5	17	10
10480 00 006	8	1/8	28	13	10
10480 00 007	8	1/4	31.5	14	10
10480 00 008	8	3/8	32	17	10
10480 00 009	10	1/4	35	16	10
10480 00 010	10	3/8	35.5	17	10
10480 00 011	10	1/2	37	21	10
10480 00 012	12	1/4	36	18	10
10480 00 013	12	3/8	37	18	10
10480 00 014	12	1/2	37	21	10
10480 00 015	14	3/8	37	20	10
10480 00 016	14	1/2	39.5	21	10
10480 00 017	15	1/2	40	21	10
10480 00 018	16	1/2	42.5	22	10
10480 00 019	16	3/4	44	27	10
10480 00 020	18	1/2	44	24	10
10480 00 021	18	3/4	45.5	27	10
10480 00 022	22	1/2	44	30	10
10480 00 023	22	3/4	45.5	30	10

10485

RACCORDO DIRITTO MASCHIO CILINDRICO

STRAIGHT MALE ADAPTOR (PARALLEL)
 GERADE EINSCHRAUBVERSCHRAUBUNG ZYLINDRISCH
 RACCORD DROIT MÂLE CYLINDRIQUE
 RACOR RECTO MACHO CILÍNDRICO
 CONEXÃO RETA COM ROSCA MACHO PARALELA

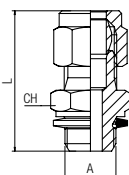

Code	Tube	A	L	CH	Pack.
10485 00 001	4	1/8	25	13	10
10485 00 002	6	1/8	26.5	13	10
10485 00 003	6	1/4	30	17	10
10485 00 004	8	1/8	28.5	13	10
10485 00 005	8	1/4	31	17	10
10485 00 006	8	3/8	34.5	22	10
10485 00 007	10	1/4	34.5	17	10
10485 00 008	10	3/8	38	22	10
10485 00 009	14	3/8	39.5	22	10
10485 00 010	14	1/2	42	27	10
10485 00 011	22	3/4	47	32	10
10485 00 012	22	1"	50	40	10



Temperature

min	max
- 20 °C	+ 80 °C

10500

RACCORDO DIRITTO FEMMINA

STRAIGHT FEMALE ADAPTOR
 AUFSCRAUBVERSCHRAUBUNG
 RACCORD DROIT TARAUEE
 RACOR RECTO HEMBRA
 CONEXÃO RETA COM ROSCA FÊMEA

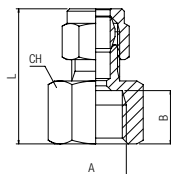

Code	Tube	A	L	CH	Pack.
10500 00 001	4	1/8	24	14	10
10500 00 002	4	1/4	26.5	17	10
10500 00 003	6	1/8	25.5	14	10
10500 00 004	6	1/4	28	17	10
10500 00 005	8	1/8	26	14	10
10500 00 006	8	1/4	28.5	17	10
10500 00 007	8	3/8	29.5	20	10
10500 00 008	10	1/4	32	17	10
10500 00 009	10	3/8	32.5	20	10
10500 00 010	10	1/2	34.5	24	10
10500 00 011	12	1/4	32	18	10
10500 00 012	12	3/8	32.5	20	10
10500 00 013	12	1/2	34.5	24	10
10500 00 014	14	3/8	34	20	10
10500 00 015	14	1/2	36.5	24	10
10500 00 016	15	1/2	36.5	24	10
10500 00 017	16	1/2	39	24	10
10500 00 018	16	3/4	40.5	30	10
10500 00 019	18	1/2	40	24	10
10500 00 020	18	3/4	41	30	10
10500 00 021	22	3/4	40	30	10

10510

RACCORDO A CROCE

EQUAL CROSS
 KREUZVERSCHRAUBUNG
 RACCORD EN CROIX
 RACOR A CRUZ
 CONEXÃO TIPO CRUZETA TUBO-TUBO

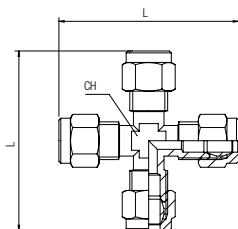

Code	Tube	L	CH	Pack.
10510 00 001	4	45	8	10
10510 00 002	6	47	9	10
10510 00 003	8	54	11	10
10510 00 004	10	64	13	10
10510 00 005	12	70	17	10
10510 00 006	14	74.5	17	10

13530

ADATTATORE ORIENTABILE MASCHIO CILINDRICO

ORIENTING MALE ADAPTOR PARALLEL
 EINSCHRAUBSTECKVERSCHRAUBUNG ZYLINDRISCH
 ADAPTATEUR D'ORIENTATION CYLINDRIQUE
 ADAPTADOR ORIENTABLE MACHO CILÍNDRICO
 ADAPTADOR ORIENTÁVEL COM ROSCA MACHO PARALELA

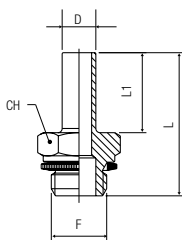

Code	D	F	L	L1	CH	Pack.
13530 00 001	6	1/8	27.5	16	13	10
13530 00 002	6	1/4	31	16	17	10
13530 00 003	8	1/8	31.5	19	13	10
13530 00 004	8	1/4	34	19	17	10
13530 00 005	8	3/8	38	19	22	10
13530 00 006	10	1/4	35	20	17	10
13530 00 007	10	3/8	39	20	22	10
13530 00 008	14	3/8	40	21	22	10
13530 00 009	14	1/2	42	21	27	10



Temperature

min	max
- 20 °C	+ 80 °C

13540

MANICOTTO PORTAGOMMA PER TUBO CAUCCIÙ

SLEEVE HOSE ADAPTER FOR CAOUTCHOUC TUBES
 SCHLAUCHTÜLLE FÜR GUMMISCHLAUCH
 DOUILLE ANNELÉE POUR TUBE CAOUTCHOUC
 MANGUITO PORTAGOMA PARA TUBO DE CAUCHO
 ESPIGÃO PARA ENGATE DE MANGUEIRAS

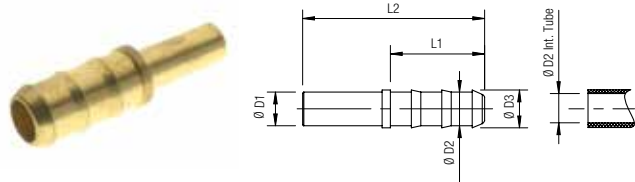

Code	D1	D2	D3	L1	L	Pack.
13540 00 01 GG 00	6	7	9	22.5	40.5	10
13540 00 01 GH 00	8	7	9	22.5	43.5	10
13540 00 01 GP 00	8	10	12	22.5	43.5	10
13540 00 01 GI 00	10	7	9	22.5	44.5	10
13540 00 01 FR 00	10	10	12	22.5	44.5	10
13540 00 01 FS 00	12	10	12	22.5	45	10
13540 00 01 GM 00	12	13	15.5	29.5	52	10
13540 00 01 GN 00	14	13	15.5	29.5	52.5	10

10550

RACCORDO ORIENTABILE A L CON VITE

SINGLE BANJO BODY WITH STEM
 WINKELSCHWENKVERSCHRÄUBUNG (DREHBAR)
 EQUERRE MÂLE BANJO, ORIENTABLE
 RACOR ORIENTABLE A L CON TORNILLO
 CONEXÃO EM "L" ORIENTÁVEL TIPO BANJO

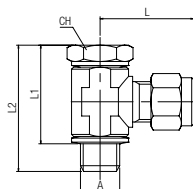

Code	Tube	A	L	L2	L1	CH	Pack.
10550 00 001	4	1/8	21.5	31	23	14	10
10550 00 002	6	1/8	23	31	23	14	10
10550 00 003	6	1/4	26	32	23.5	17	10
10550 00 004	8	1/8	26.5	31	23	14	10
10550 00 005	8	1/4	27	32	23.5	17	10
10550 00 006	8	3/8	28	36	26.5	19	10
10550 00 007	10	1/4	31.5	32	23.5	17	10
10550 00 008	10	3/8	32.5	36	26.5	19	10
10550 00 009	14	1/4	36.5	44	36.5	17	10
10550 00 010	14	3/8	36.5	46	37	22	10
10550 00 011	14	1/2	36.5	49	38	24	10
10550 00 012	22	3/4	45.5	64	52	32	10

	min	max
Temperature	- 20 °C	+ 80 °C

10680

DADO

NUT
 ÜBERWURFMUTTER
 ECROU
 TUERCA
 PORCA

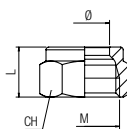

Code	Tube	L	CH	M	Pack.
10680 00 01 X1 NB	4	9.5	10	M 8x1	50
10680 00 01 X4 NB	6	10.5	12	M 10x1	50
10680 00 01 X7 NB	8	11.5	14	M 12x1	50
10680 00 01 X9 NB	10	13.5	19	M 16x1.5	50
10680 00 01 Y1 NB	12	13.5	21	M 18x1.5	50
10680 00 01 Y3 NB	14	14.5	23	M 20x1.5	20
10680 00 01 Y4 NB	15	16	23	M 20x1.5	20
10680 00 01 Y5 NB	16	17	25	M 22x1.5	20
10680 00 01 Y7 NB	18	18	28	M 24x1.5	20
10680 00 01 J1 NB	22	18	34	M 30x1.5	10

10740

OGIVA OTTONE

BRASS OLIVE
 KLEMMRING MESSING
 BAGUE LAITON
 OJIVA LATÓN
 BUCHA DE LATÃO

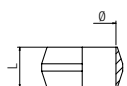

Code	Tube	L	Pack.
10740 00 02 X1 00	4	5.5	50
10740 00 02 X4 00	6	6.5	50
10740 00 02 X7 00	8	6.5	50
10740 00 02 X9 00	10	7.5	50
10740 00 02 Y1 00	12	8	50
10740 00 02 Y3 00	14	8.5	20
10740 00 02 Y4 00	15	9	20
10740 00 02 Y5 00	16	9.5	20
10740 00 02 Y7 00	18	10	20
10740 00 02 J1 00	22	10	10

10760

OGIVA PTFE

PTFE OLIVE
KLEMMRING PTFE
BAGUE PTFE
OJIVA PTFE
BUCHA EM PTFE

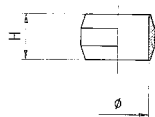

Code	Tube	H	Pack.
10760 00 28 X1 00	4	5.5	50
10760 00 28 X4 00	6	6.5	50
10760 00 28 X7 00	8	6.5	50
10760 00 28 X9 00	10	7.5	50
10760 00 28 Y1 00	12	8	50
10760 00 28 Y3 00	14	8.5	50
10760 00 28 Y4 00	15	9	50
10760 00 28 Y5 00	16	9.5	50
10760 00 28 Y7 00	18	10	50
10760 00 28 J1 00	22	10	50

10770

BUSSOLA DI RINFORZO

INTERNAL SUPPORT BUSH
STÜTZHÜLSE MESSING
FOURRURE INTÉRIEURE
REFUERZO
BUCHA DE REFORÇO INTERNA

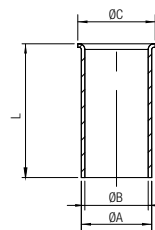

Code	Tube	A	B	C	L	Pack.
10770 00 01 1D 00	4/2.7	2.7	2.1	3.7	13	10
10770 00 01 3D 00	6/4	4	3.2	5	13	10
10770 00 01 4D 00	8/6	6	5	7	16.5	10
10770 00 01 5D 00	10/8	8	7	9	17	10
10770 00 01 7D 00	12/9	9	8	11	19	10
10770 00 01 8D 00	12/10	10	9	11	19	10
10770 00 01 0E 00	14/12	12	11	13.5	21	10
10770 00 01 1E 00	15/12.5	12.5	11.6	14	21	10
10770 00 01 3E 00	16/13	13	12	15.5	22	10
10770 00 01 7E 00	18/15	15	14	17.5	23	10
10770 00 01 8E 00	18/16	16	15	17.5	23	10
10770 00 01 0F 00	22/18	18	17	21	25	10

13780

TAPPO PER RACCORDI UNIVERSALI

PLUG FOR UNIVERSAL FITTINGS
STOPFEN FÜR DOPPELKEGEL VERSCHRAUBUNGEN
BOUCHON POUR RACCORDES UNIVERSELS
TAPÓN PARA RACORES UNIVERSALES
TAMPÃO PARA CONEXÃO UNIVERSAIS

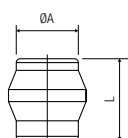

Code	Tube	L	Pack.
13780 00 01 X1 00	4	10	50
13780 00 01 X4 00	6	10.5	50
13780 00 01 X7 00	8	10.5	50
13780 00 01 X9 00	10	11.5	50
13780 00 01 Y1 00	12	12	50
13780 00 01 Y3 00	14	14	20
13780 00 01 Y4 00	15	14	20
13780 00 01 Y5 00	16	14	20
13780 00 01 Y7 00	18	16	20
13780 00 01 J1 00	22	15	20

1612

RONDELLA BIMATERIALE IN ACCIAIO E NBR

STEEL AND NBR BIMATERIAL WASHER
VERBUNDDICHTRINGE AUS STAHL UND NBR
RONDELLE-JOINT BI-MATIÈRE (NBR - ACIER)
ARANDELA BIMATERIAL EN ACERO Y NBR
ARRUELA BI-MATERIAL EM AÇO E NBR

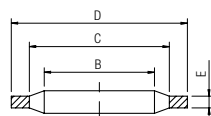

Code	Size	B	C	D	E	Pack.
01612 00 001	1/8	10.4	12	14.7	1.25	20
01612 00 002	1/4	13.85	15.75	18.7	1.25	20
01612 00 003	3/8	17.35	19.25	22.7	1.25	20
01612 00 004	1/2	21.65	23.55	26.7	1.25	20
01612 00 005	3/4	27.3	29.2	32.5	1.25	20
01612 00 006	1"	34.2	36.1	39.5	2	20



Temperature

min

- 30 °C

max

+ 100 °C

1613

RONDELLA AUTOCENTRANTE BIMATERIALE IN ACCIAIO E NBR

STEEL AND NBR CENTERING BIMATERIAL WASHER
BI-MATERIAL STAHL SCHEIBE UND NBR
RONDELLE JOINT BI-MATIÈRE - ACIER/NBR
ARANDELA BIMATERIAL EN ACERO Y NBR
ARRUELA BI-MATERIAL EM AÇO E NBR

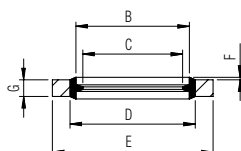

Code	Size	B	C	D	E	G	F	Pack.
01613 00 001	1/8	10,37	8,56	11,84	14	2	0,3	20
01613 00 002	1/4	13,74	11,45	15,21	17	2	0,3	20
01613 00 003	3/8	17,28	14,96	18,75	22	2	0,3	20
01613 00 004	1/2	21,54	18,64	23,01	26	2,5	0,4	20
01613 00 005	3/4	27,05	24,13	28,53	32	2,5	0,4	20
01613 00 006	1"	33,89	30,30	36,88	41	3,2	0,5	20



Temperature

min

- 30 °C

max

+ 100 °C

