

## PISTOLE DI SOFFIAGGIO

BLOW GUNS

BLASPISTOLEN

SOUFFLETES

PISTOLAS SOPLADORAS

PISTOLA DE AR

# Serie 300

Aggiornamento - Updated - Stand - Updated - Actualização - Atualização 09/2016



Aignep si riserva il diritto di variare modelli e ingombri senza preavviso - Aignep reserves the right to vary models and dimensions without notice - Aignep behält sich das Recht vor, Daten ohne Ankündigung zu ändern  
Aignep se reserva el derecho de modificar modelos y dimensiones sin previo aviso - Aignep reserva-se o direito de alterar os modelos e dimensões sem prévio aviso  
Aignep se réserve le droit de modifier les données sans préavis - Aignep se reserva o direito de alterar os modelos e dimensões sem prévio aviso





**CARATTERISTICHE TECNICHE**  
 TECHNICAL CHARACTERISTICS  
 TECHNISCHE ANGABEN  
 CARACTÉRISTIQUES TECHNIQUES  
 CARACTERÍSTICAS TÉCNICAS  
 CARACTERÍSTICAS TÉCNICAS



1907/2006  
**REACH** ✓

2011/65/CE  
**RoHS** ✓

PED  
 2014/68/UE

SILICON  
 FREE

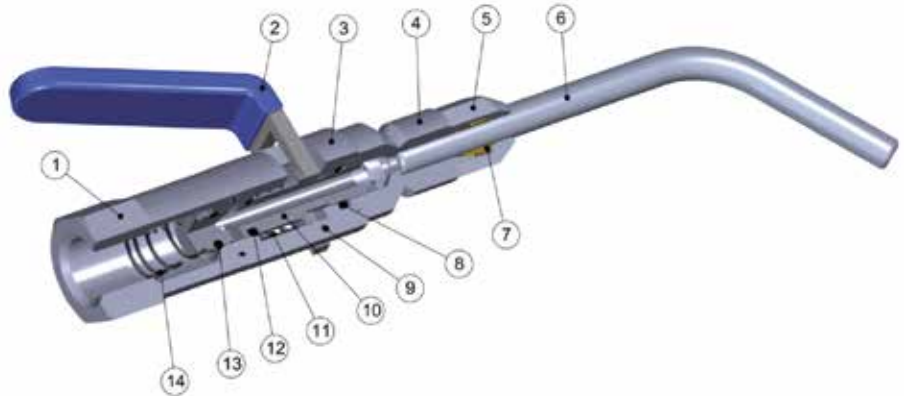

**Materiali e Componenti**

IT

- 1 Attacco terminale in Ottone nichelato
- 2 Maniglia in ottone Nichelato Plastificata
- 3 Corpo centrale in ottone Nichelato
- 4 Corpo anteriore in ottone Nichelato
- 5 Dado di serraggio in ottone Nichelato
- 6 Ugello di soffiaggio in acciaio A10 Nichelato
- 7 Ogiva aggraffaggio tubo in ottone giallo
- 8 Guarnizione O-Ring in NBR 70
- 9 Spina in Acciaio
- 10 Pistoncino in ottone Nichelato
- 11 Molla contrasto Pistoncino in acciaio AISI 302
- 12 Guarnizione O-Ring in NBR 70
- 13 Guarnizione O-Ring in NBR 70
- 14 Molla posteriore Pistoncino in acciaio AISI 302

**Component Parts and Materials**

GB

- 1 Nickel-plated Brass Back Connection
- 2 Nickel-plated Brass Handferro Plastified
- 3 Nickel-plated Brass Central Body
- 4 Nickel-plated Brass Front Body
- 5 Nickel-plated Brass Locking nut
- 6 Nickel-plated inox Nozzle
- 7 Yellow Brass Clamping olive
- 8 NBR 70 O-RING Seals
- 9 Steel Pin
- 10 Nickel-plated Brass Plunger
- 11 Steel AISI 302 Plunger thrust spring
- 12 NBR 70 O-RING Seals
- 13 NBR 70 O-RING Seals
- 14 Steel AISI 302 Plunger back Spring

**Komponenten und Materialien**

DE

- 1 Einschraubkörper Messing vernickelt
- 2 Handgriff Messing vernickelt Plastifiziert
- 3 Zentralkörper Messing vernickelt
- 4 Vorderkörper Messing vernickelt
- 5 Sicherungsmutter Messing vernickelt
- 6 Blasdüsenrohr Stahl A10 vernickelt
- 7 Klemmung Messing
- 8 O-Ring NBR 70
- 9 Stahlstift
- 10 Kolben Messing vernickelt
- 11 Stosskolbenfeder Edelstahl AISI 302
- 12 O-Ring NBR 70
- 13 O-Ring NBR 70
- 14 Rückstellkolbenfeder Edelstahl AISI 302

**Matériaux et Composants**

FR

- 1 Corps: laiton nickelé
- 2 Gachette: laiton nickelé, plastifié
- 3 Corps: laiton nickelé
- 4 Corps: laiton nickelé
- 5 Ecrou: laiton nickelé
- 6 Embout: acier inoxydable nickelé
- 7 Bague olive: laiton
- 8 Joint torique: NBR 70
- 9 Goupille: acier
- 10 Clapet: laiton nickelé
- 11 Ressort: acier inoxydable AISI 302
- 12 Joint torique: NBR 70
- 13 Joint torique: NBR 70
- 14 Ressort: acier inoxydable AISI 302

**Materiales y Componentes**

ES

- 1 Conexión terminal en latón niquelado
- 2 Maneta en latón niquelado plastificada
- 3 Cuerpo central en latón niquelado
- 4 Cuerpo anterior en latón niquelado
- 5 Tuerca de bloqueo en latón niquelado
- 6 Boquilla de soplado en acero A10 niquelado
- 7 Bicono sujeción tubo en latón
- 8 Junta tórica en NBR 70
- 9 Perno en acero
- 10 Pistón en latón niquelado
- 11 Muelle empuje pistón en acero AISI 302
- 12 Junta tórica en NBR 70
- 13 Junta tórica en NBR 70
- 14 Muelle posterior pistón en acero AISI 302

**Materialis e Componentes**

PT

- 1 Conexão terminal em Latão niquelado
- 2 Manopla em Latão niquelado Plastificada
- 3 Corpo central em Latão niquelado
- 4 Corpo frontal em Latão niquelado
- 5 Porca de travamento em Latão niquelado
- 6 Bico de sopro em aço A10 niquelado
- 7 Bucha de travamento do tubo em Latão
- 8 Vedação O-Ring em NBR 70
- 9 Pina em Aço
- 10 Pistão em Latão niquelado
- 11 Mola do Pistão em aço AISI 302
- 12 Vedação O-Ring em NBR 70
- 13 Vedação O-Ring em NBR 70
- 14 Mola traseira do Pistão em aço AISI 302



**Pressione d'esercizio**

Working Pressures

Betriebsdruck

Pression de service

Presión de Ejercicio

Pressão de Trabalho

**10 bar (1 MPa)**



**Temperature**

Temperatures

Temperatur

Températures

Temperaturas

Temperaturas

**- 20 °C  
 + 80 °C**



**Fluidi compatibili**

Aria compressa

Fluids

Compressed air

Geeignete Medien

Druckluft

Fluides compatibles

Air comprimé

Fluidos compatibles

Aire comprimido

Fluidos compatíveis

Ar comprimido



**Filettatura**

IT

Gas cilindrica conforme ISO 228 Classe A.  
 Metrica conforme ISO R/262.

**Threads**

GB

Parallel gas in conformity with ISO 228 Class A.  
 Metric in conformity with ISO R/262.

**Gewindearten**

DE

Zylindrisches Gewinde nach Norm ISO 228 Classe A.  
 Metrisches Gewinde nach Norm ISO R/262.

**Filetages**

FR

Filetage cylindrique conforme: ISO 228 Class A.  
 Filetage métrique conforme: ISO R/262.

**Roscas**

ES

Gas cilíndrica conforme ISO 228 Clase A.  
 Métrica conforme ISO R/262.

**Roscas**

PT

Gas paralela conforme ISO 228 Classe A.  
 Métrica conforme ISO R/262.

**321**

**PISTOLA DI SOFFIAGGIO - ATTACCO FEMMINA**

BLOW GUN FEMALE CONNECTION  
 BLASPISTOLE MIT INNENGEWINDE  
 SOUFFLETTE, TARAUEE  
 PISTOLA DE SOPLADO - HEMBRA  
 PISTOLA DE AR - ROSCA FÊMEA

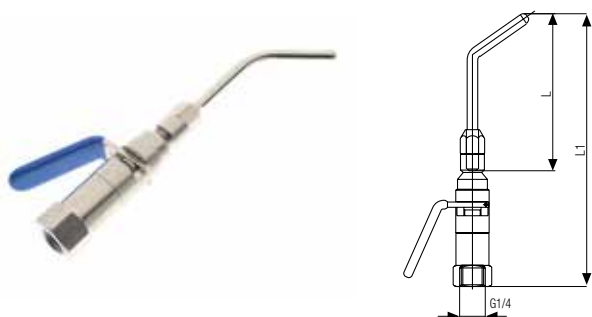

Code	L	L1	Pack.
00321 00 001	90	157	10
00321 00 002	200	267	1
00321 00 003	290	357	1

**322**

**PISTOLA DI SOFFIAGGIO CON SCHERMO D'ARIA PROTETTIVO  
 ATTACCO FEMMINA**

BLOW GUN WITH PROTECTIVE AIR-SCREEN - FEMALE CONNECTION  
 BLASPISTOLE MIT INNENGEWINDE UND LUFTBLLENDE  
 SOUFFLETTE AVEC ÉCRAN D'AIR DE SÉCURITÉ - TARAUEE  
 PISTOLA DE SOPLADO CON PANTALLA DE AIRE - PROTECTORA HEMBRA  
 PISTOLA DE AR COM TELA DE AR PROTETIVA - ROSCA FÊMEA

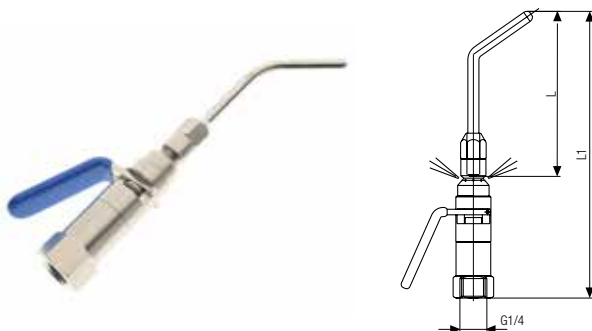

Code	L	L1	Pack.
00322 00 001	90	157	10
00322 00 002	200	267	1
00322 00 003	290	357	1

**325**

**PISTOLA DI SOFFIAGGIO - ATTACCO A CALZAMENTO CON MOLLA**

BLOW GUN - PUSH-ON CONNECTION WITH SPRING  
 BLASPISTOLE MIT ÜBERWURFVERSCHRÄUBUNG UND KNICKSCHUTZFEDER  
 SOUFFLETTE, CONNEXION À COIFFE AVEC RESSORT DE PROTECTION  
 PISTOLA DE SOPLADO - CONEXIÓN TUBO CON MUELLE  
 PISTOLA DE AR - CONEXÃO PUSH-ON COM MOLA



Code	L	A	L1	Pack.
00325 00 001	90	8/6	250.5	1
00325 00 002	90	10/8	251.5	1
00325 00 003	200	8/6	360.5	1
00325 00 004	200	10/8	361.5	1
00325 00 005	290	8/6	450.5	1
00325 00 006	290	10/8	451.5	1

**326**

**PISTOLA DI SOFFIAGGIO CON SCHERMO D'ARIA PROTETTIVO  
ATTACCO A CALZAMENTO CON MOLLA**

BLOW GUN WITH PROTECTIVE AIR SCREEN - PUSH-ON CONNECTION WITH SPRING  
BLASPISTOLE MIT ÜBERWURFVERSCHRAUBUNG UND KNICKSCHUTZFEDER  
UND LUFTBLLENDE

SOUFFLETTE AVEC ÉCRAN D'AIR DE SÉCURITÉ, CONNEXION À COIFFE AVEC  
RESSORT DE PROTECTION

PISTOLA DE SOPLADO CON PANTALLA DE AIRE - PROTECTORA PARA CONEXIÓN TUBO CON MUELLE

PISTOLA DE AR COM TELA DE AR PROTETIVA E CONEXÃO PUSH-ON COM MOLA

Code	L	A	L1	Pack.
00326 00 001	90	8/6	250.5	1
00326 00 002	90	10/8	251.5	1
00326 00 003	200	8/6	360.5	1
00326 00 004	200	10/8	361.5	1
00326 00 005	290	8/6	450.5	1
00326 00 006	290	10/8	451.5	1

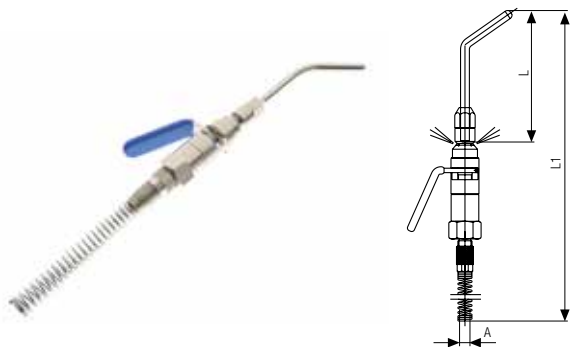

**310**

**UGELLO DIRITTO (RICAMBIO)**

STRAIGHT NOZZLE (SPARE PART)

GERADE DÜSE (ERSATZTEIL)

EMBOUT DROIT (RECHANGE)

BOQUILLA RECTA (RECAMBIO)

BICO RETO (REPOSIÇÃO)

Code	L	Pack.
00310 00 001	100	1
00310 00 002	210	1
00310 00 003	300	1

Ogni ugello è completo di dado e ogiva.

Every nozzle is supplied with nut and olive.

Jede düse ist komplett mit mutter und klemmring.

L'embout est livré avec un écrou et une bague

Cada boquilla está completa de tuerca y bicono.

Todo bico é fornecido completo, com porca e bucha para montagem.

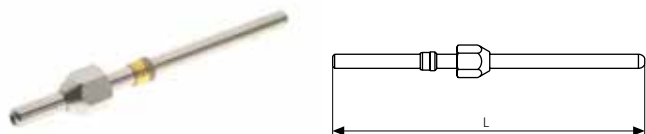

**311**

**UGELLO ANGOLATO (RICAMBIO)**

ELBOW NOZZLE (SPARE PART)

ABGEWINKELTE DÜSE (ERSATZTEIL)

EMBOUT COUDÉ (RECHANGE)

BOQUILLA ANGULADA (RECAMBIO)

BICO ANGULADO (REPOSIÇÃO)

Code	L	Pack.
00311 00 001	90	1
00311 00 002	200	1
00311 00 003	290	1

Ogni ugello è completo di dado e ogiva.

Every nozzle is supplied with nut and olive.

Jede düse ist komplett mit mutter und klemmring.

L'embout est livré avec un écrou et une bague

Cada boquilla está completa de tuerca y bicono.

Todo bico é fornecido completo, com porca e bucha para montagem.

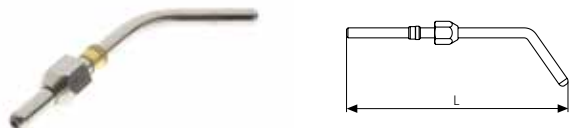

**312**

**UGELLO EFFETTO VENTURI (RICAMBIO)**

VENTURI'S EFFECT NOZZLE (SPARE PART)

VENTURI DÜSE (ERSATZTEIL)

EMBOUT À EFFET VENTURI (RECHANGE)

BOQUILLA EFECTO VENTURI (RECAMBIO)

BICO COM EFEITO VENTURI (REPOSIÇÃO)

Code	L	D	Pack.
00312 00 001	55	17	1

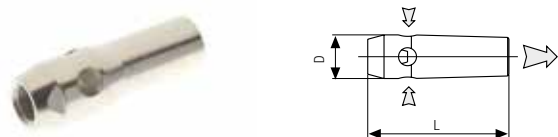

**340**

**PISTOLA DI SOFFIAGGIO Ø 6 mm ATTACCO FEMMINA IN TECNOPOLIMERO**

BLOWGUN WITH Ø 6 mm BENT PIPE FEMALE POLYMER THREAD  
 BLASPISTOLE MIT DÜSENROHR Ø 6 mm, ANSCHLUSS AUS POLYMER  
 SOUFFLETTE AVEC EMBOUT Ø 6 mm, RACCORDEMENT EN POLYMÈRE  
 PISTOLA DE SOPLADO Ø 6 mm HEMBRA EN TECNOPOLÍMERO  
 PISTOLA DE AR COM BICO DE Ø 6 mm COM CONEXÃO FÊMEA EM TECNOPOLÍMERO

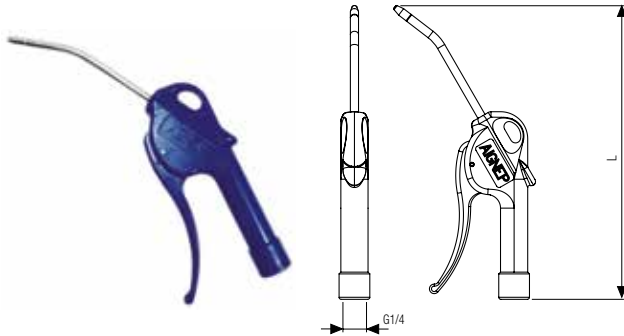

Code	L	Pack.
00340 00 001	215	1
	<b>min</b>	<b>max</b>
<b>Temperature</b>	- 10 °C	+ 80 °C
<b>Pressure</b>		+ 16 bar (1.6 MPa)
<b>380 NI/min - 85 dB - 8 bar</b>		

**341**

**PISTOLA DI SOFFIAGGIO Ø 6 mm CON ATTACCO FEMMINA IN METALLO**

BLOWGUN WITH Ø 6 mm BENT PIPE WITH METAL BUSHING  
 BLASPISTOLE MIT DÜSENROHR Ø 6 mm, ANSCHLUSS AUS METALL  
 SOUFFLETTE AVEC EMBOUT Ø 6 mm, RACCORDEMENT MÉTALLIQUE  
 PISTOLA DE SOPLADO Ø 6 mm HEMBRA CON CASQUILLO METÁLICO  
 PISTOLA DE AR COM BICO DE Ø 6 mm COM CONEXÃO FÊMEA EM METAL

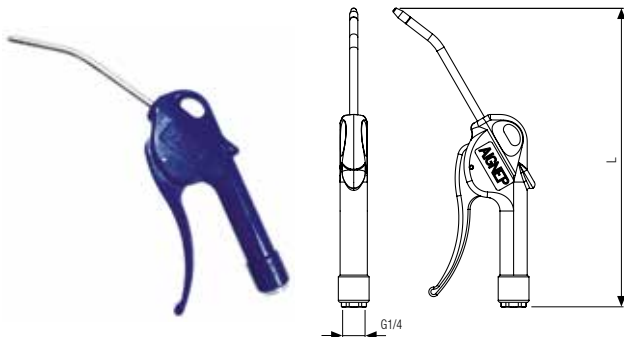

Code	L	Pack.
00341 00 001	217	1
	<b>min</b>	<b>max</b>
<b>Temperature</b>	- 10 °C	+ 80 °C
<b>Pressure</b>		+ 16 bar (1.6 MPa)
<b>380 NI/min - 85 dB - 8 bar</b>		

## 342

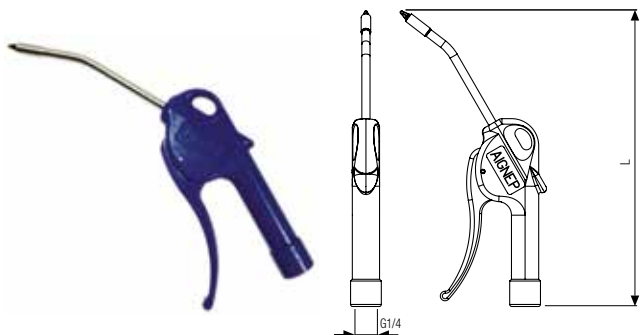
**PISTOLA DI SOFFIAGGIO Ø 6 mm INOX CON TUBO RICURVO SUPER SILENZIOSA**
*BLOWGUN WITH Ø 6 mm STAINLESS BENT PIPE SUPER SILENT*
*BLASPISTOLE MIT EDELSTAHL DÜSENROHR Ø 6 mm, SEHR LEISE*
*SOUFFLETTE AVEC EMBOUT INOX Ø 6 mm, SILENCIEUSE*
*PISTOLA DE SOPLADO Ø 6 mm INOX CON TUBO CURVADO SUPER SILENCIOSA*
*PISTOLA DE AR COM BICO DE Ø 6 mm EM INOX CURVADO SUPER SILENCIOSO*

## 343

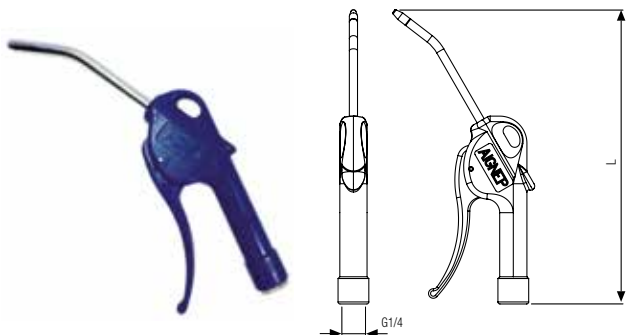
**PISTOLA DI SOFFIAGGIO DI SICUREZZA A 3,5 BAR CON TUBO RICURVO DA Ø 8 mm**
*BLOWGUN WITH Ø 8 mm BENT PIPE - 3,5 BAR MAX OUTLET*
*SICHERHEITS-BLASPISTOLE BIS 3,5 BAR MIT ABGEWINKELTEM DÜSENROHR Ø 8 mm*
*SOUFFLETTE DE SÉCURITÉ AVEC EMBOUT Ø 8 mm - PRESSION DE SORTIE 3,5 BAR*
*PISTOLA DE SOPLADO DE SEGURIDAD A 3,5 BAR CON TUBO CURVADO DE Ø 8 mm*
*PISTOLA DE AR DE SEGURANÇA PARA 3,5 BAR COM TUBO CURVADO DE Ø 8 mm*

Code	L	Pack.
00342 00 001	215	1

	min	max
<b>Temperature</b>	- 10 °C	+ 60 °C
<b>Pressure</b>		+ 12 bar (1.2 MPa)
<b>380 NI/min - 85 dB - 8 bar</b>		
<b>SUVA approved</b>		

Code	L	Pack.
00343 00 001	217	1

	min	max
<b>Temperature</b>	- 10 °C	+ 80 °C
<b>Pressure</b>		+ 16 bar (1.6 MPa)
<b>380 NI/min - 85 dB - 8 bar</b>		

